

EN



INSTALLATION GUIDELINES

INSTALLATION/SERVICING/MAINTENANCE/SAFETY ADVICE



IN-GROUND POOL COVER
CF COVERKIT B-4.1 BAR
PACK4



CONTENTS

Fitting the bolts.....	p. 18
Tensioning the cover	p. 19
Creating the side strap buckle	p. 20
Tensioning the side straps	p. 21
USE.....	p. 22
UPKEEP/MAINTENANCE.....	p. 23
Water level of the pool	p. 23
Filtering and treating the water.....	p. 23
Upkeep (the customer's responsibility)	p. 24
Maintenance	p. 25
Wintering.....	p. 26
SAFETY TIPS.....	p. 27
RECYCLING	p. 29
REGULATIONS.....	p. 30
WARRANTY CONDITIONS.....	p. 30





DESCRIPTION

COMPONENTS PROVIDED

PACK4 PACKAGE B







 1.685 m	P-MAPS22101	x 2
 1 m	P-MAPS22100	x 2
 30 cm	P-MAPS22000	x 8
	CBPAT	x 10
	A-ARAC01200	x 10
	A-VMTF20400	x 67
 PZ2		x 1
 10,2 m	P-ARSA07701	x 2
	A-FIPRO2902	x 6
	A-FIMA04101	x 2
	A-FIMA04100	x 2
	P-ARSA07110	x 5
	P-ARSA07108	x 3
	P-ARSA07109	x 3
	A-ARAC03103	x 2
 1,6 m		x 1
	P-SBB411401	x 1
	CABMAN2	x 1
 21 m	P-ARSA07700	x 1

PACK4 PACKAGE A

 1.85 m	P-MAPS22102	x 2
 1.685 m	P-MAPS22101	x 4
 1 m	P-MAPS22100	x 2
	P-SBB411401	x 2
	A-DOTE05115	x 1







OPTION PACK4 PACKAGE C



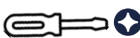

 1.685 m	P-MAPS22101	x 2
 1 m	P-MAPS22100	x 1
 30 cm	P-MAPS22000	x 2
	CBPAT	x 2
	A-VMTF20400	x 19
	A-FIPRO2902	x 2
	P-SBB411400	x 2

DESCRIPTION



TOOLS REQUIRED FOR ASSEMBLY



	Phillips screwdriver PZ2
	Screwdriver
	PZ2
	Punch
	Ø12 Concrete

	Tape measure
	Hammer
	Pencil
	Mallet

PACKING LIST

	<p>PACK4 - 2 PACKAGE</p> <p>PACK4 PACKAGE A : 1.90 x 0.24 x 0.20 m - 24 Kg</p> <p>PACK4 PACKAGE B : 1.90 x 0.24 x 0.20 m - 23 Kg</p>
	<p>"Extension Option"</p> <p>PACK4 PACKAGE C : 1.72 x 0.14 x 0.12 - 8 Kg</p>

ASSEMBLY









2 persons



2 hours 45

INFORMATION

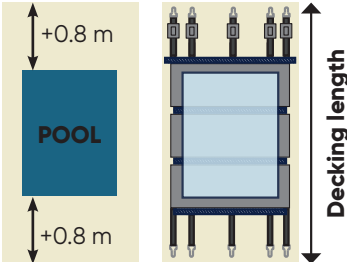
PREREQUISITES

	<p>The water level must be maintained once the cover is installed.</p> 								
	<p>Fitting the bolts and holding them in place is a major factor in the safety of the cover, so they should only be attached to a solid surface, such as concrete dosed at 350Kg/m³, with or without paving. Never attach to coping stones.</p> <p>The concrete decking must be at least 10 cm thick.</p> <p>Any other support such as a lawn, duckboard or slab on the ground should be avoided.</p>								
	<p>The decking must be flat and level throughout.</p> <p>Decking area required : Decking = pool +0.8 m minimum</p> <table border="1" data-bbox="271 855 639 1054"> <thead> <tr> <th>example: Pool width 4m</th> <th>Decking length</th> </tr> </thead> <tbody> <tr> <td>PACKAGE A4</td> <td>8.60 m</td> </tr> <tr> <td>PACKAGE B4 + 1 extension C4</td> <td>9.60 m</td> </tr> <tr> <td>PACKAGE B4 + 2 extensions C4</td> <td>10.60 m</td> </tr> </tbody> </table>  <p>The cover must rest on the coping stones with clearance of at least 20 cm all-round the pool.</p> <p>The maximum width of the pool is 4.06m.</p>	example: Pool width 4m	Decking length	PACKAGE A4	8.60 m	PACKAGE B4 + 1 extension C4	9.60 m	PACKAGE B4 + 2 extensions C4	10.60 m
example: Pool width 4m	Decking length								
PACKAGE A4	8.60 m								
PACKAGE B4 + 1 extension C4	9.60 m								
PACKAGE B4 + 2 extensions C4	10.60 m								
	<p>The cover is not designed for infinity pools or above-ground pools.</p>								
	<p>Always wear safety equipment.</p>								
	<p>Practise using the ratchets (tightening and loosening) before fitting.</p>								

! WE RECOMMEND READING ALL THE INSTALLATION STEPS BEFORE INSTALLING THE SYSTEM, TO AVOID UNNECESSARY HANDLING.

INSTALLATION

EXAMPLE ASSEMBLY



SCAN TO VIEW THE COVERKIT B-4
BAR COVER ASSEMBLY TUTORIAL.









1



FIRST DOWNLOAD A FREE QR READER.



INSTALLATION

ASSEMBLING THE WINDING BAR

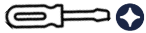
			
		1.85 m	x2
		1 m	x1
		30 cm	x2
			x8

	
	Screwdriver PZ2
	Screwdriver
	PZ2

1.85 m

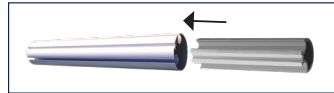

1 m



1.85 m



4.70 m



Recommendations for successful tightening:

- Manual tightening is preferable.
- With the screwdriver, at speed 1, set the clutch to the appropriate torque.
- Always finish tightening by hand.

INSTALLATION

ASSEMBLING INTERMEDIATE BARS

	1.685 m	x6	
	1 m	x3	
	30 cm	x6	
			x24

	Screwdriver PZ2
	Screwdriver
	PZ2

1.685 m

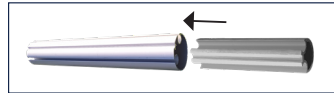

1 m



1.685 m



4.37 m







Recommendations for successful tightening:

- Manual tightening is preferable.
- With the screwdriver, at speed 1, set the clutch to the appropriate torque.
- Always finish tightening by hand.

INSTALLATION

ASSEMBLING CANVAS AND BARS

		
	4.70 m	x 1
	4.37 m	x 3
		x 3



FITTING THE CANVAS STRIPS AND BARS TO THE DECKING

To be carried out on a clear, flat, non-abrasive surface (terrace, lawn).

- Slide the bar across the canvas
- > Slide the canvas into the bar

Remember to assemble the "extension" options

- Proceed with caution.
- Align and guide the CANVAS as it is inserted into the profile.
- Never force it.
- Insertion should be straightforward.

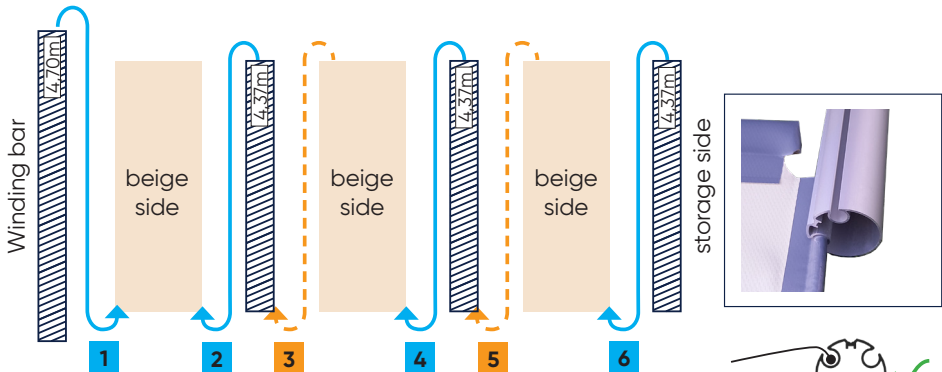

With "Extension" options
Place the extensions at the ends of the cover.

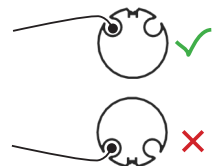
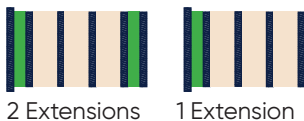

INSTALLATION

FITTING THE STRAPS ON THE WINDING BAR

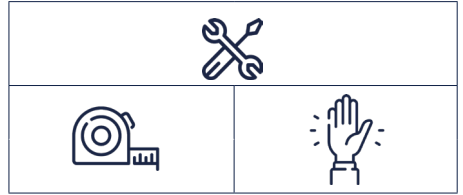
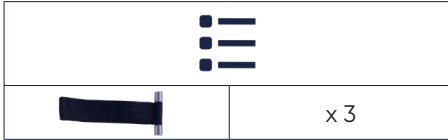

THREAD THE METAL ROD THROUGH THE GROOVE IN THE TUBE AND POSITION THE STRAPS AS SHOWN BELOW.

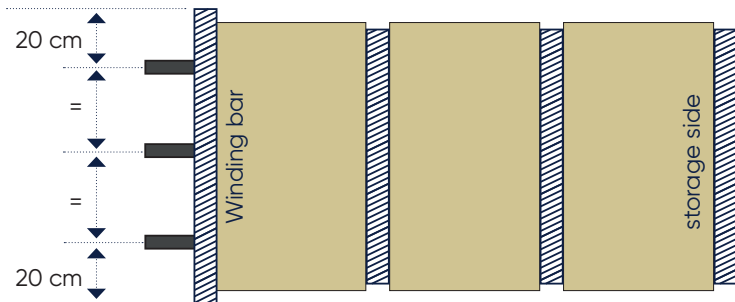
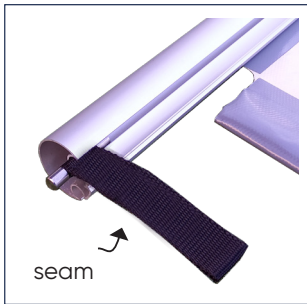

INSTALLATION

FITTING THE STRAPS ON THE STORAGE SIDE

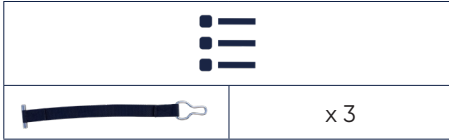

THREAD THE METAL ROD THROUGH THE GROOVE IN THE TUBE AND POSITION THE STRAPS AS SHOWN BELOW.

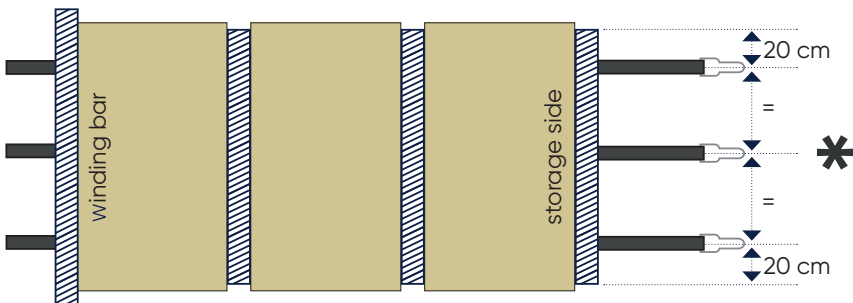
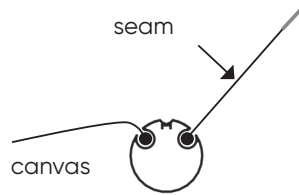
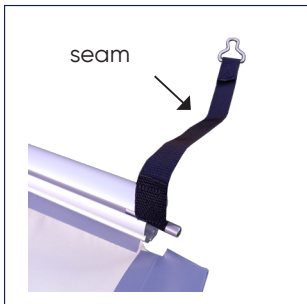

- * With a skimmer in the centre:
* The central strap can be offset by a maximum of 30 cm to either side of the skimmer.

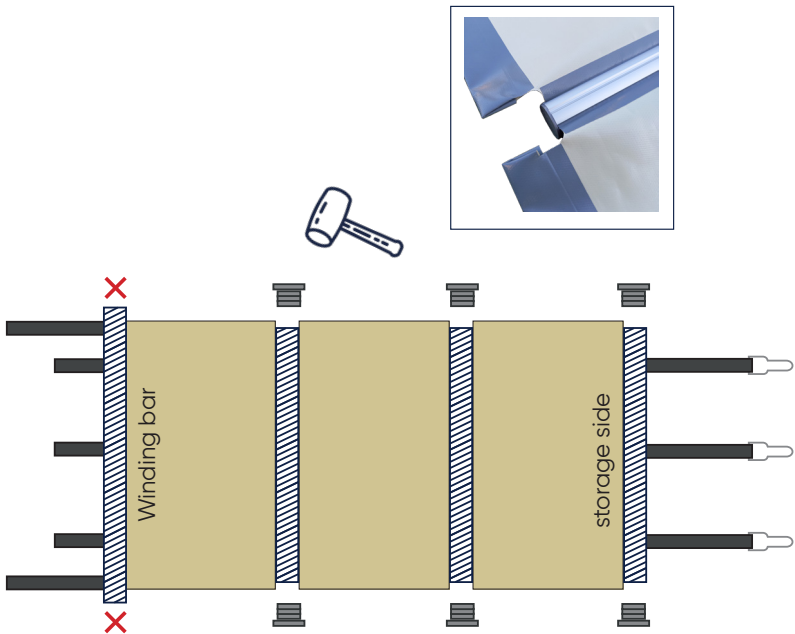
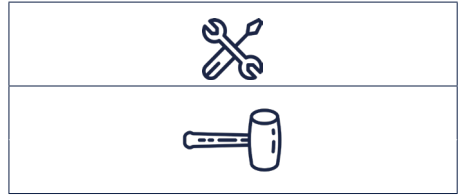

INSTALLATION

FITTING SIMPLE PLUGS



INSTALLATION

FITTING THE WINDING PLUGS

	
	x 2
	x 2

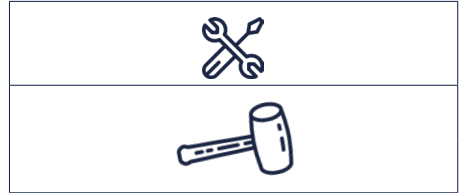

1

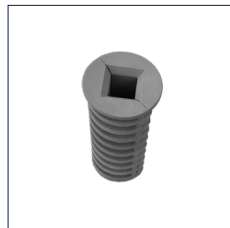
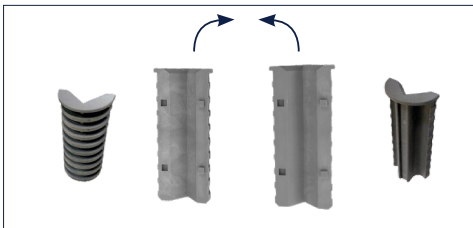



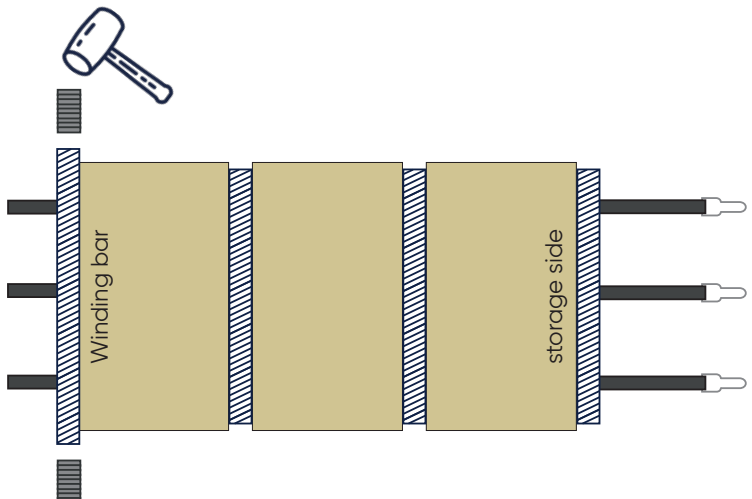
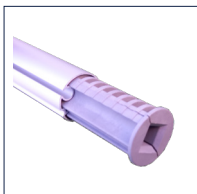



2



INSTALLATION

FITTING THE RUNNERS

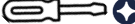
	
	x 10
	x 30

	
	Screwdriver PZ2
	Screwdriver
	PZ2

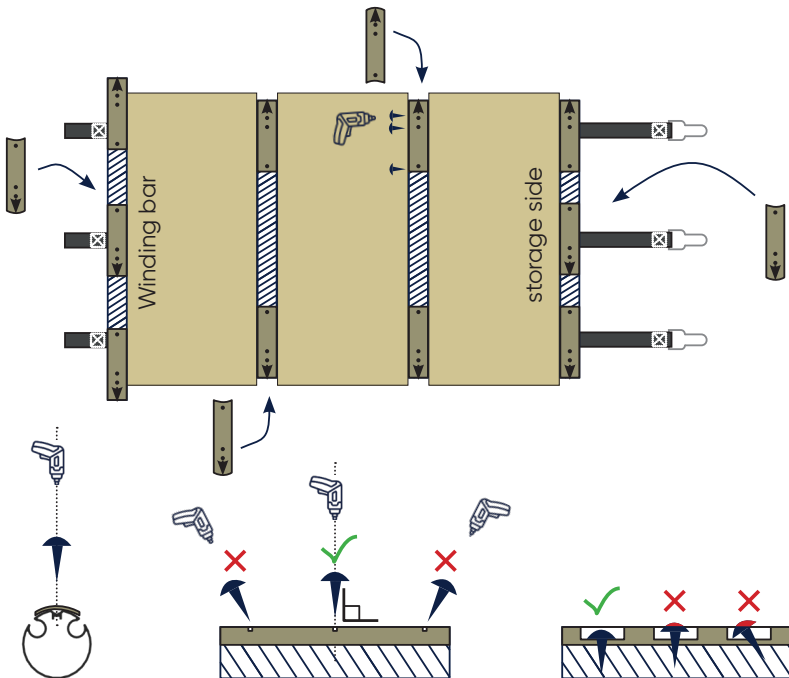



Recommendations for successful tightening:

- With the screwdriver in speed 2 (fast), set the clutch to a low torque and always finish tightening by hand.

INSTALLATION

FITTING THE CONNECTING SIDE STRAPS

	
 10,2 m	x 2
	x 1





1 HOOK THE BUNGEE CORD TO THE STRAP

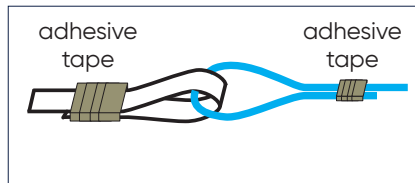

or

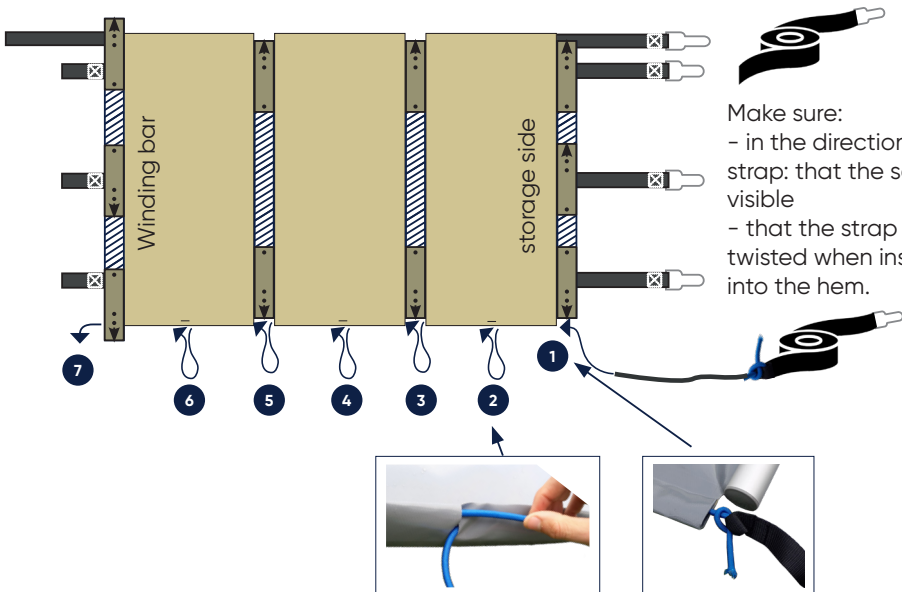

2 PASS THE STRAPS THROUGH THE HEM OF THE CANVAS



INSTALLATION

FIT THE COVER OVER THE POOL



1 TURN THE COVER OVER

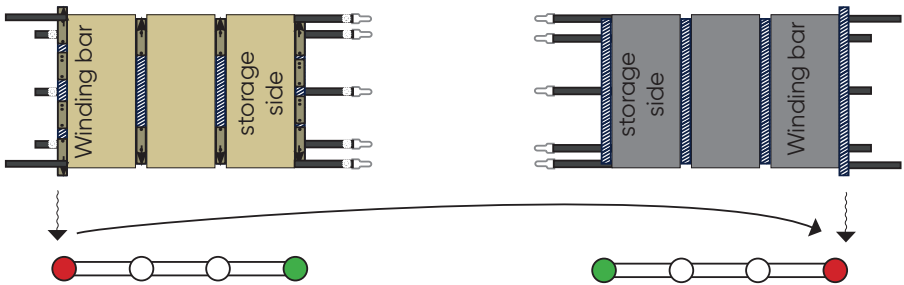

2 PLACE THE COVER ON THE POOL

Choose the storage side (the storage side is the side where the cover will remain when the pool is open). Rotate the cover 180° if necessary.

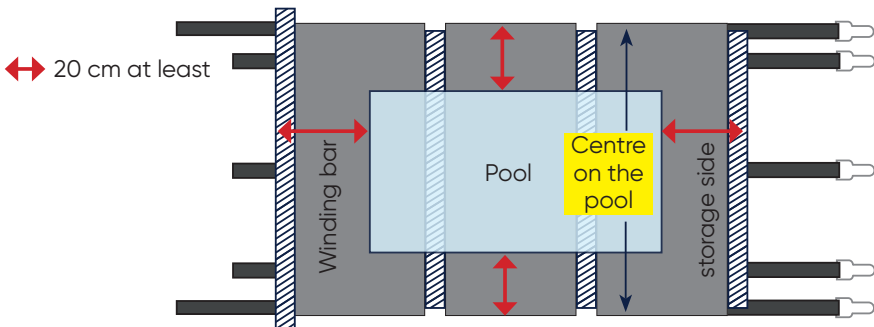

INSTALLATION

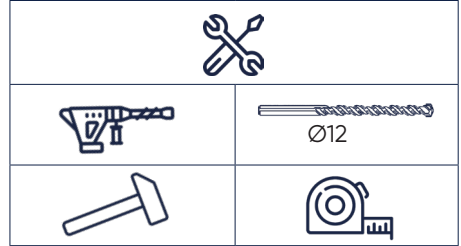
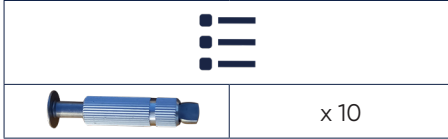

1

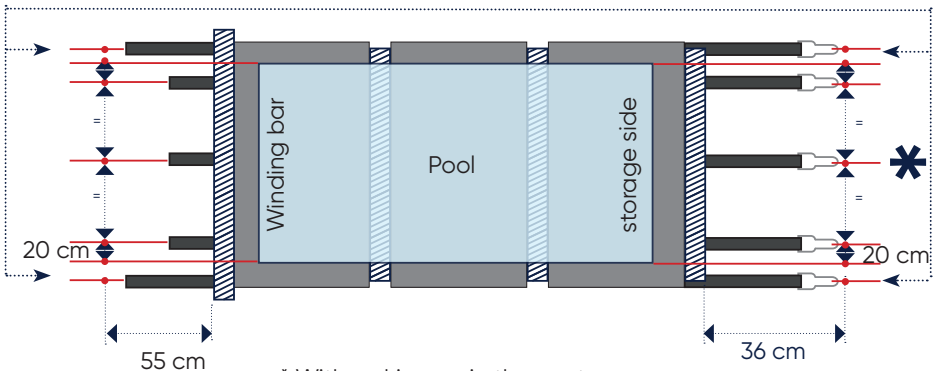

* With a skimmer in the centre:
The central strap can be offset by a maximum of 30 cm to either side of the skimmer.



Note on the next steps:

If, as a result of faulty drilling, the bolt sleeves appear to be loose in the paving, the sleeve should be ovalised with a hammer.

2 DRILLING

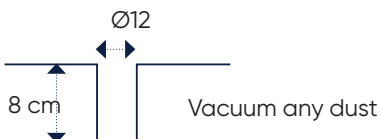

3

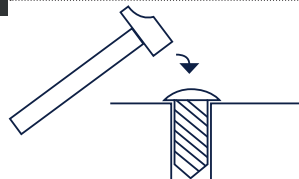

INSTALLATION

TENSIONING THE COVER

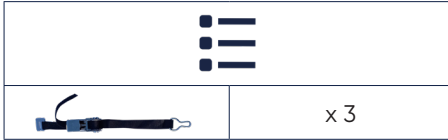

1 ON THE STORAGE SIDE, ATTACH THE RINGS TO THE BOLTS

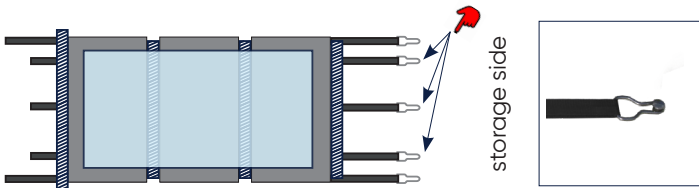

2 ON THE WINDING SIDE, HOOK THE RING OF THE STRAP TO THE BOLT AND HOOK THE "S" INTO THE CANVAS BUCKLE.

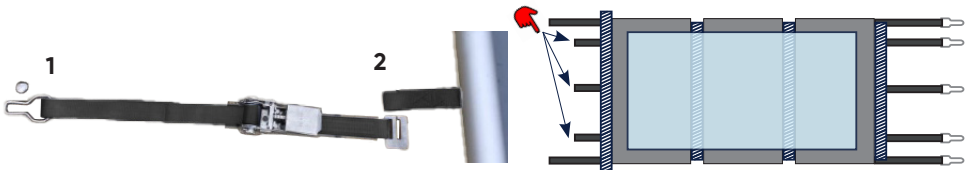

3 TIGHTEN THE RATCHET

Gradually tension the 3 ratchets to 50%, then in a second stage finish tensioning to 100%.

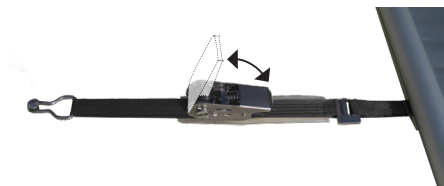

INSTALLATION

CREATING THE SIDE STRAP BUCKLE

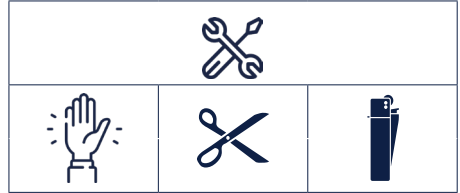

1 ON THE STORAGE SIDE, ATTACH THE RING TO THE BOLT

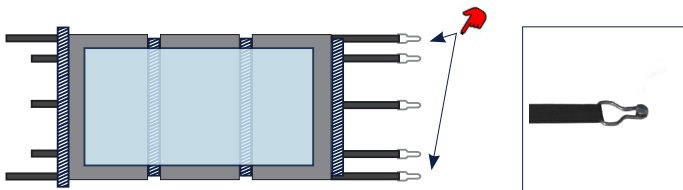

2 ON THE WINDING SIDE, INSTALL THE STAINLESS STEEL ADJUSTMENT BUCKLE

Tension and fold the strap in half to pass it through the buckle

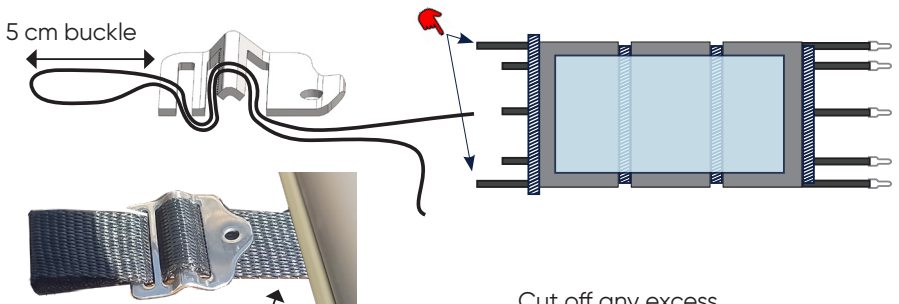

The adjustment buckle should be positioned as close as possible to the bar.

Cut off any excess straps with scissors and melt the cut part with a lighter.

3 DO THE SAME TO THE OTHER STRAP

INSTALLATION

TENSIONING THE SIDE STRAPS

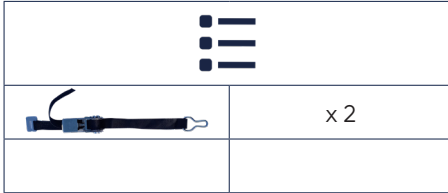

1 ON THE STORAGE SIDE, ATTACH THE BUCKLE TO THE BOLT

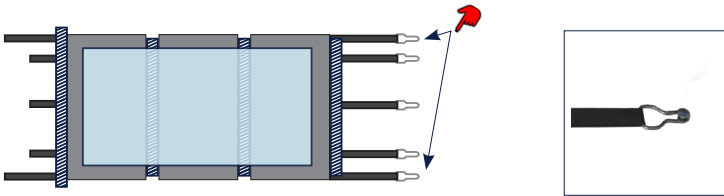

2 ON THE WINDING SIDE, ATTACH THE STRAP RING TO THE BOLT AND HOOK THE "S" CONNECTOR INTO THE CANVAS BUCKLE

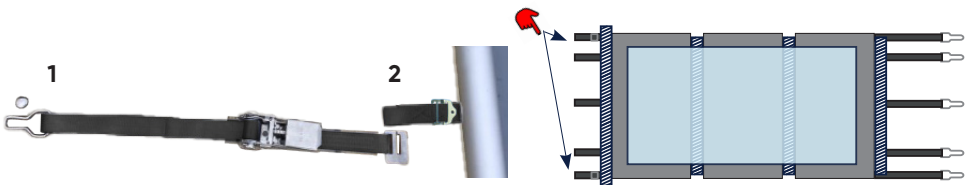

3 TIGHTEN THE RATCHET

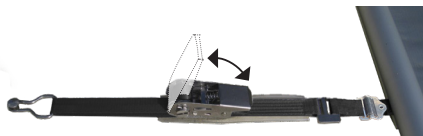

4 DO THE SAME TO THE OTHER STRAP

USE

OPENING / CLOSING THE POOL

Before doing this, check that there are no bathers present and always keep an eye on the pool when opening and closing it. You must open or close the cover completely; never leave it in an intermediate position.

Always check that the water level in the pool remains constant and complies with the manufacturer's recommendations. Never walk on the cover when it is in place, otherwise the crossbars may become distorted.

CLOSING THE POOL

- Unroll the cover by pulling on the unwinding strap
- Centre the cover on the pool
- Attach the ratchets to the straps on the cover
- For above-ground pools, use bungee clips

When closed, the cover must have a support of at least 20 cm on the coping stones.

OPENING THE POOL

- Loosen the straps by loosening the ratchets (release by lifting the snap tab), then remove them so they don't get rolled up in the cover (risk of tears not under warranty)
- Position the unwinding strap (centred on the width) by activating the quick-release buckle.
- Connect the end of the crank handle (male) to the winding shaft (female).
- Roll up the cover using the crank handle.

SERVICING/MAINTENANCE



During any intervention, the technician must wear PPE (personal protective equipment): gloves, goggles, mat, etc...

WATER LEVEL IN THE POOL

- In order to ensure maximum safety and correct operation of the rewinder, always check that the water level in the pool remains constant and complies with the manufacturer's requirements (for greater comfort, use an overflow and a water level regulator).
- A water level that is too high is due to the overflow being obstructed by leaves or other items.
- Recommended water level: between 7 cm and 15 cm below the top of the coping.

WATER FILTRATION AND TREATMENT

- Programme filtration to take place at a time when the sun is shining on the pool and ensure that it is set to work all the time when the water reaches 25°C.
- In order to ensure that your installation will last, the water in the pool must be correctly treated in compliance with the applicable standards and recommendations (NF EN 16713-3).
- The pH, hardness and alkali levels of the water must be checked and adjusted as often as is necessary (although you will need to ensure that you don't correct these three parameters independently of each other but do so using the Taylor table and provide the water with balance with regard to the three parameters analysed).

SERVICING/MAINTENANCE

SERVICING (customer's responsibility)

- Carry out a deep clean of the cover twice per year (the first time in the year it is used and prior to Wintering). This is even more important if the water in the pool is limestone. In this case, use a descaling cleaning product (see catalogue) and rinse using a hose.
- Do not allow leaves to accumulate and decompose on the cover.
- Clean the cover regularly by removing it from the pool and placing it flat on a suitable surface (watch out for plants and sharp objects that could damage the cover). Rinse both sides of the cover under running water and, if necessary, clean the dirtiest areas with a non-abrasive sponge (soak the sponge in pool water line cleaner if necessary).
- Do not use abrasive products or solvents to clean the cover.
- It is best to inspect the entire system if the cover is forced to bear unexpected weight at any time (fall).
- Carry out an annual check of the straps.
- Socket hooks and pawls must be cleaned and lubricated regularly to prevent them from deteriorating, which could present a risk (foot injuries in the event of an impact or fall). In the event of damage, replace defective parts with original ones.

SERVICING/MAINTENANCE

MAINTENANCE (ONCE PER YEAR MINIMUM)

- This product does not have any wear parts requiring replacement. However, if you notice that certain parts are deteriorating, please ensure that they are replaced.
- All spare parts must come from the manufacturer or comply with standard NF P90-308.
- Check that the installation is working correctly.
- Inspect the cover thoroughly.
- At the start of each season and in the event of an accident (a falling object, hail on the cover, abnormal stress on the cover, etc.), check that the cover has not suffered any visible damage likely to compromise its safety (cracks, holes, deformations, etc.). If necessary, replace parts or the entire roof.
- Check the state of the straps (seams) and in particular the wear on the anti-abrasion sleeve. If the latter is no longer fulfilling its role of protecting the strap against abrasions from the pool rim, then replace it.
- Customer service: contact details on back page of document.

EACH TIME IT IS USED

- Carry out a visual check of the fastening and drive components.
every 3 months

EVERY 3 MONTHS

- Carry out a complete cleaning.

EVERY 4 MONTHS AND AFTER ANY EXCEPTIONAL EVENT (FALLING OBJECT, HEAVY RAIN, STORM, SNOW, PARTICULAR IMPACT, ETC.)

- Carry out a thorough check of all the components of the cover (condition and assembly of fabric, seams, straps, ratchets, hooks, anti-abrasion pads, etc.).

SERVICING/MAINTENANCE

WINTERING

- Position the cover in the closed position and keep the water level constant in accordance with the manufacturer's recommendations.



- During the winter season, in the event of snowfall, it is essential to remove the snow from the cover using a brush with a telescopic handle to avoid deforming the crossbars.

SAFETY ADVICE

Please read the recommendations set out below with care.

WARNING

Swimming pools can represent a serious danger for your children. Drowning can happen very quickly.

Children who are close to a swimming pool need to be watched constantly and actively, even if they know how to swim.

Learn lifesaving skills.

The physical presence of an adult is absolutely essential whenever the pool is open.



Memorise the telephone numbers for the emergency services and ensure that they are displayed close to the pool.

 **18** (in France) or **112**

FIRE SERVICE

 **15**

AMBULANCE
SERVICE

(write the number that applies in your region)



POISON CONTROL

CENTRE

SAFETY ADVICE

- This section is by no means a replacement for common sense or individual responsibility. Its aim is not to replace the vigilance of parents and/or responsible adults, who remain the essential factor in ensuring the protection of young children.
- **Warning:** safety is only guaranteed when the cover is closed, locked and correctly installed in compliance with the manufacturer's instructions.
- The cover must systematically be closed if you are absent from home, even for a very short period.
- Check that no persons and no foreign objects are in the pool before and during opening and closing operations.
- Store the devices and/or tools needed to operate the covers out of the reach of children.
- Operation of the mechanism must only be carried out by a responsible adult.
- With the exception of movable floors, movable terraces and the covering elements provided for this purpose (e.g. gratings), do not climb, walk or jump on a safety cover.
- Take all necessary measures to prevent access to the pool for young children until the cover is repaired or when a malfunction is observed that prevents closing or in case of temporary unavailability of the equipment or the pool.
- Respect the water levels designated by the manufacturer.
- Children must not play with the appliance.
- This appliance may be used by children aged 8 and over, and by persons with reduced physical, sensory or mental capabilities or lack of experience and knowledge if they have received supervision or instructions concerning the safe use of the appliance and understand the hazards involved.

A child can drown in less than 3 minutes; no type of protection can ever replace the watchful eye and vigilance of a responsible adult.

RECYCLING

PACKAGING

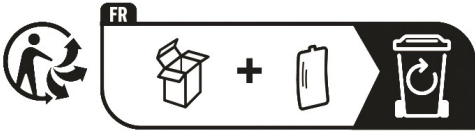

Dispose of the packaging in line with current rules and regulations.

END OF LIFECYCLE



- Do not put your scrapped equipment or used batteries in with unsorted household waste.
- You are responsible for disposing of all of your waste, in particular electrical and electronic equipment by taking it to a collection point where recycling and valorisation are carried out.
- Certain products potentially contain substances that are dangerous for the environment, and you need to ensure that these are eliminated or neutralised.
- Make sure that you are aware of all existing recovery and collection systems.



discard the manual in line with the current regulations.

REGULATIONS

STANDARD

- This cover complies with standard NFP 90-308.
- Specific cases of non-compliance:
 1. A pool larger than the following maximum dimensions:
 - Pack 3m: maximum pool width between coping stones 3.06 m (minimum width: 2.50m).
 - Pool lengths between coping stones: 7.02 / 8.02 / 9.02 m maximum depending on the number of C extensions (0/1/2).
 2. If the decking is not made of concrete (e.g. wood, natural soil) at the anchor points (located 80cm from the edge of the standard pool).
 3. If the area around the pool is not accessible for safety operations.
 4. Strong winds in excess of 70 km/h.
 5. This product is not suitable for infinity and above-ground pools.
- Protective elements for unenclosed in-ground private swimming pools for individual or collective use.
- To ensure full compliance, the conditions of installation and use specified in the technical manual must be observed.
- The bars are not designed to be dismantled and reassembled, as this will impair their technical qualities.

WARRANTY CONDITIONS

The canvas and aluminium bars are guaranteed against material and/or manufacturing defects for 3 years from the date of delivery.

The other parts (strap, crank, stainless steel bolts, fixing ring, anti-abrasion pads, end plugs) are guaranteed against material and/or manufacturing defects for 3 years from the date of delivery.^

NOTES

SAS AQUALUX
ZAC DE LA MASSANE
287 AVENUE DE LA MASSANE
13210 ST RÉMY DE PROVENCE - FRANCE

☎ +33 (0)9 70 72 5000 / INFO.FR@CF.GROUP

STAMP

A brand by CF group

