

# ORDER FORM

## AZTECK POOL KITS

# AZTECK

Customer N°:	Customer reference:	Order form date:
--------------	---------------------	------------------

<b>Company contact details:</b> Surname: ..... Postcode: ..... City: ..... Country: ..... Phone: ..... E-mail: .....	<b>Delivery address:</b> Name: ..... Address: ..... Postcode: ..... City: ..... Country: ..... Phone (person to contact): ..... Access: <input type="checkbox"/> Semi-trailer <input type="checkbox"/> Carrier Other: ..... Fill in the truck access checking guide on p. 43.
---	--

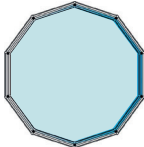
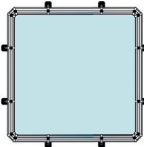
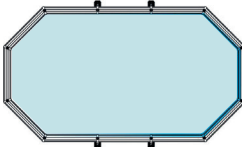
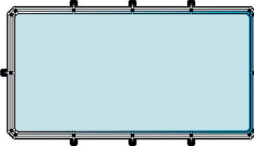
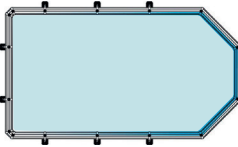
POOL SHAPE AND DIMENSIONS (in m)				
				
<input type="checkbox"/> Ø 4.40 <input type="checkbox"/> Ø 5.40	<input type="checkbox"/> 3.00 x 3.00 <input type="checkbox"/> 3.50 x 3.50 <input type="checkbox"/> 4.05 x 4.05	<input type="checkbox"/> 4.00 x 5.60 <input type="checkbox"/> 4.00 x 7.30 <input type="checkbox"/> 4.00 x 8.90	<input type="checkbox"/> 2.50 x 5.10 <input type="checkbox"/> 3.00 x 3.50 <input type="checkbox"/> 3.50 x 5.10 <input type="checkbox"/> 3.50 x 6.70	<input type="checkbox"/> 3.50 x 8.30 <input type="checkbox"/> 4.05 x 5.60 <input type="checkbox"/> 4.05 x 7.30 <input type="checkbox"/> 4.05 x 8.90

CHOICE OF INSTALLATION			LINER COLOUR CHOICE
<input type="checkbox"/> Above-ground	<input type="checkbox"/> Half-inground	<input type="checkbox"/> Inground	<input type="checkbox"/> Beige <input type="checkbox"/> White <input type="checkbox"/> Steel grey <input type="checkbox"/> Adriatic blue <input type="checkbox"/> Ice blue

COLOUR OF THE CASING*			
Choice	Coping	Posts	Wall facings (7 + 2 for above-ground ; 3 + 1 for half-inground ; 1 for inground)
<input type="checkbox"/>	Slate grey (dark)	Slate grey (dark)	Slate grey (dark)
<input type="checkbox"/>	Slate grey (dark)	Slate grey (dark)	Iroise grey + 1 slate grey belt (dark)**
<input type="checkbox"/>	Exotic brown (dark)	Exotic brown (dark)	Exotic brown (dark)
<input type="checkbox"/>	Exotic brown (dark)	Exotic brown (dark)	Colorado brown (light)*** + exotic brown belt (dark)**
<input type="checkbox"/>	Colorado brown (light)***	Colorado brown (light)**	Colorado brown (light)***
<input type="checkbox"/>	Colorado brown (light)***	Colorado brown (light)***	Exotic brown (dark) + colorado brown*** belt** (light)

\* No mixed choice of colour for inground version.

\*\* Belt for above-ground installation = 2 rows of walls. Half-inground installation = 1 row of walls.

\*\*\* Subject to availability.

ACCESSORIES		
<input type="checkbox"/> Filter cartridge - ref. CC5	<input type="checkbox"/> Cleaning products <input type="radio"/> Silvanet - ref. SILVANET <input type="radio"/> Wichinox - ref. A-P39437	<input type="checkbox"/> Water treatment products <input type="radio"/> Starter pack - ref. A-P40130

OPTIONS	
<input type="checkbox"/> Automatic slatted cover <input type="radio"/> Rollenergy Evolution - Please complete the corresponding order form. <input type="radio"/> Rolleasy 2 - Please complete the corresponding order form.	<input type="checkbox"/> Skimdress (Azteck built-in pump room) <input type="radio"/> Standard Skimdress for cartridge filter <input type="radio"/> XL Skimdress for sand filter
<input type="checkbox"/> 4-seasons cover Equinox - Please complete the corresponding order form.	<input type="checkbox"/> Chlorinator
<input type="checkbox"/> Summer cover - ref.: .....	<input type="checkbox"/> Heat pump - ref.: .....
<input type="checkbox"/> Reel system for summer cover <input type="radio"/> Vega reel ref. W-ENPT01200 <input type="radio"/> Vega mobile reel ref. W-ENPT01202 <input type="radio"/> Vega removable reel ref. W-P39382 <input type="radio"/> Orion reel ref. W-ENPT02200 <input type="radio"/> Orion removable reel ref. W-P39381	<input type="checkbox"/> By-pass <input type="radio"/> For standard Skimdress ref. BPHSPAC <input type="radio"/> For XL Skimdress
<input type="checkbox"/> Winter cover - ref.: .....	<input type="checkbox"/> RGB bulb for LED projector

Please send this order form to: [export@cf.group](mailto:export@cf.group)

## ORDER FORM

# ROLLEASY 2 AUTOMATIC COVER FOR AZTECK POOL KITS (1/2)

Customer N°:	Customer reference:	Order form date:
--------------	---------------------	------------------

<b>Company contact details:</b> Surname: ..... Postcode: ..... City: ..... Country: ..... Phone: ..... E-mail: .....	<b>Delivery address:</b> Name: ..... Address: ..... Postcode: ..... City: ..... Country: ..... Phone (person to contact): ..... Access: <input type="checkbox"/> Semi-trailer <input type="checkbox"/> Carrier Other: ..... Fill in the truck access checking guide on p. 43.
---	--

New build pool     Existing pool: in order to avoid taking again measurements of the pool, please indicate the invoice number, order number or reference of the original cover made: .....

<b>DEL</b>	
<b>VERSION</b>	
<input type="checkbox"/> Manual <input type="checkbox"/> Electric <input type="checkbox"/> Solar	
<b>END-STAND COLOUR (by default, they will be white)</b>	
<input type="checkbox"/> Beige RAL 1015 <input type="checkbox"/> Grey RAL 7040 <input type="checkbox"/> Dark green RAL 6005 <input type="checkbox"/> Dark grey RAL 7016 <input type="checkbox"/> Black RAL 9005	
<b>INFO</b> For all these colours: 10 days extra lead time	
<b>CLOSING CONTROLS</b>	
<input type="checkbox"/> Maintain contact (default choice) <input type="checkbox"/> Impulse on	
<b>OPTIONS</b>	
<b>Adaptation kit for Azteck pool</b> <input checked="" type="checkbox"/> Yes <b>Coping cut-out trim</b> <input checked="" type="checkbox"/> Yes <b>LivePool</b> (only for the electric version) <input type="checkbox"/> Yes <input type="checkbox"/> No	
<b>SLATS</b>	
<b>Opaque PVC 69 slats</b>	
<input type="checkbox"/> White <input type="checkbox"/> Beige <input type="checkbox"/> Grey <input type="checkbox"/> Blue*	
<b>Solar polycarbonate slats - 69 mm</b>	
<input type="checkbox"/> Crystal black <input type="checkbox"/> Silver <input type="checkbox"/> Crystal blue* <input type="checkbox"/> Crystal* <input type="checkbox"/> Crystal brown* <input type="checkbox"/> Crystal green* (Polycarbonate slats are not compatible with bromine treatments)	
<input type="radio"/> Leave one slat out of three without endcap to ease the sliding of the slats: <input type="radio"/> AD side <input type="radio"/> BC side By default, all the endcaps will be fitted.	
* Additional lead time.	
<b>LOCKING KITS</b>	
<input type="checkbox"/> <b>Pushlock (flat hanging fittings):</b> <input type="radio"/> White <input type="radio"/> Beige <input type="radio"/> Grey <input type="radio"/> Blue	
<b>WINTER SHIFT / PROTECTIVE COVERING</b>	
<b>Ivernea:</b> <input type="checkbox"/> Yes (please complete the corresponding order form) <input type="checkbox"/> No <b>Ivernea Plus:</b> <input type="checkbox"/> Yes (please complete the corresponding order form) <input type="checkbox"/> No	

ORDER FORM

# ROLLEASY 2 AUTOMATIC COVER FOR AZTECK POOL KITS (2/2)

Customer N°:	Customer reference:	Order form date:	Company:
--------------	---------------------	------------------	----------

**POOL SHAPE AND DIMENSIONS (in m)**

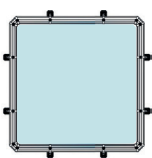
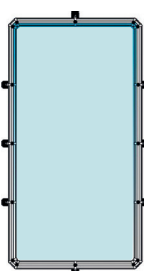
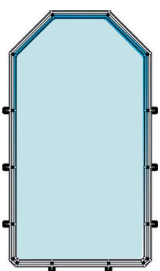
<input type="checkbox"/> <b>Square</b>  <input type="checkbox"/> 3.00 x 3.00 <input type="checkbox"/> 3.50 x 3.50 <input type="checkbox"/> 4.05 x 4.05	<input type="checkbox"/> <b>Rectangular</b>  <input type="checkbox"/> 2.50 x 5.10 <input type="checkbox"/> 3.50 x 8.30 <input type="checkbox"/> 3.00 x 3.50 <input type="checkbox"/> 4.05 x 5.60 <input type="checkbox"/> 3.50 x 5.10 <input type="checkbox"/> 4.05 x 7.30 <input type="checkbox"/> 3.50 x 6.70 <input type="checkbox"/> 4.05 x 8.90	<input type="checkbox"/> <b>Mixed</b>  Fill in the dimensions below.
---	--	---

**TAKING POOL MEASUREMENTS**

A 1 = ..... cm    B 1 = ..... cm  
 A 2 = ..... cm    B 2 = ..... cm  
 A 3 = ..... cm    B 3 = ..... cm  
 A 4 = ..... cm    B 4 = ..... cm  
 A 5 = ..... cm    B 5 = ..... cm  
 A 6 = ..... cm    B 6 = ..... cm  
 A 7 = ..... cm    B 7 = ..... cm  
 A 8 = ..... cm    B 8 = ..... cm  
 A 9 = ..... cm    B 9 = ..... cm  
 A 10 = ..... cm    B 10 = ..... cm  
 A 11 = ..... cm    B 11 = ..... cm  
 A 12 = ..... cm    B 12 = ..... cm  
 2 - 5 = ..... cm    5 - 8 = ..... cm  
 8 - 11 = ..... cm    C - 1 = ..... cm  
 C - 12 = ..... cm

**INTERIOR POOL DIMENSIONS TO BE TAKEN AT THE WATER LINE AFTER COATING HAS BEEN MADE - MIXED-SHAPE AZTECK POOL KIT**

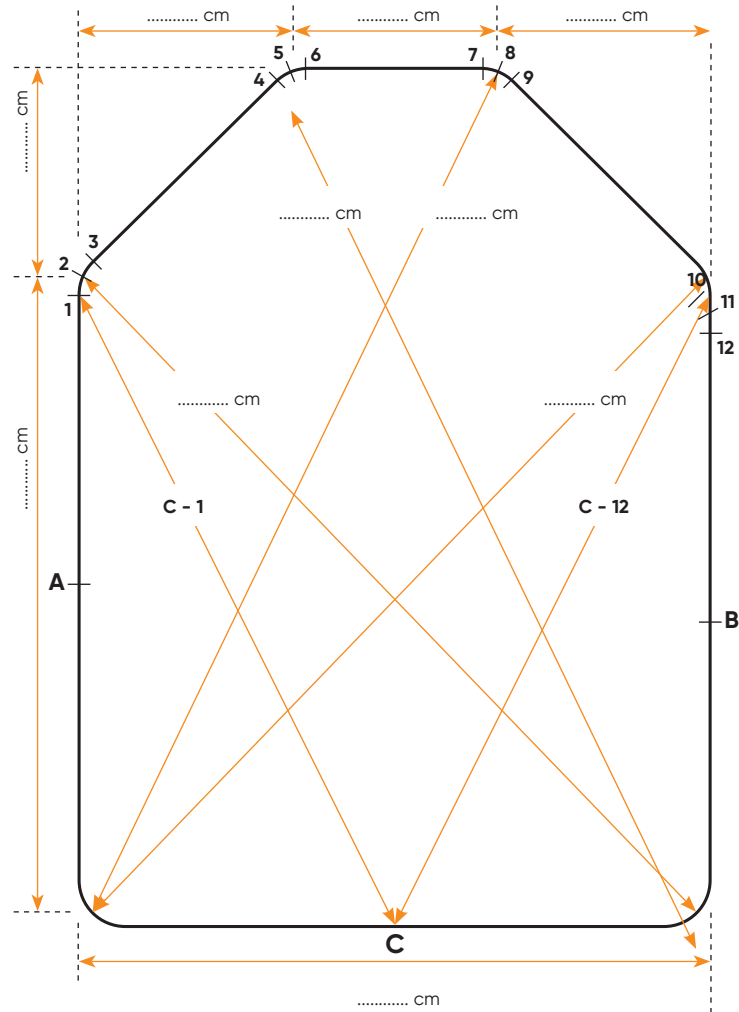

**ADDITIONAL INDICATIONS IF REQUIRED**

**TUBE / REEL SYSTEM SIDE**

## ORDER FORM

# ROLLENERGY EVOLUTION AUTOMATIC COVER FOR AZTECK POOL KITS (1/2)

	Speed fabrication required:	FROM NOVEMBER TO MARCH	APRIL	FROM MAY TO AUGUST	SEPTEMBER, OCTOBER
	<input type="checkbox"/> Yes <input type="checkbox"/> No	D+5	D+6	D+7	D+6

Customer N°:	Customer reference:	Order form date:
--------------	---------------------	------------------

<b>Company contact details:</b> Surname: ..... Postcode: ..... City: ..... Country: ..... Phone: ..... E-mail: .....	<b>Delivery address:</b> Name: ..... Address: ..... Postcode: ..... City: ..... Country: ..... Phone (person to contact): ..... Access: <input type="checkbox"/> Semi-trailer <input type="checkbox"/> Carrier Other: ..... Fill in the truck access checking guide on p. 43.
---	--

New build pool    Existing pool: in order to avoid taking again measurements of the pool, please indicate the invoice number, order number or reference of the original cover made: .....

	
<b>CONTROL</b>	<input type="checkbox"/> Wi-Key <input type="checkbox"/> Key switch <input type="checkbox"/> Insert mount key switch (indoor use)
<b>CLOSING CONTROL</b>	<input type="checkbox"/> Maintain contact (default choice) <input type="checkbox"/> Impulse on
<b>OPTIONS</b>	
<b>Adaptation kit for Azteck pools</b>	<input checked="" type="checkbox"/> Yes
<b>Junction box</b>	<input type="checkbox"/> Yes <input type="checkbox"/> No
<b>Junction box gel</b> (set of 2 cartridges)	<input type="checkbox"/> Yes <input type="checkbox"/> No
<b>Earth-grounding:</b>	Ø 50 mm <input type="checkbox"/> Yes <input type="checkbox"/> No
	Ø 63 mm <input type="checkbox"/> Yes <input type="checkbox"/> No
<b>SLATS</b>	
<b>Opaque PVC 69 slats</b>	
<input type="checkbox"/> White <input type="checkbox"/> Beige <input type="checkbox"/> Grey <input type="checkbox"/> Blue*	
<input type="radio"/> Leave one slat out of three without end cap to ease the sliding of the slats: <input type="radio"/> AD side <input type="radio"/> BC side By default, all endcaps will be installed.	
<b>Solar polycarbonate slats - 69 mm</b> (not compatible with bromine treatment)	
<input type="checkbox"/> Crystal black <input type="checkbox"/> Silver <input type="checkbox"/> Crystal blue* <input type="checkbox"/> Crystal* <input type="checkbox"/> Crystal brown* <input type="checkbox"/> Crystal green*	
<input type="radio"/> Leave one slat out of three without end cap to ease the sliding of the slats: <input type="radio"/> AD side <input type="radio"/> BC side By default, all endcaps will be installed.	
<b>Opaque PVC 84 slats</b>	
<input type="checkbox"/> White <input type="checkbox"/> Grey	
* Additional lead time.	
<b>LOCKING KITS</b>	
<input type="checkbox"/> Pushlock (flat hanging fittings): <input type="radio"/> White <input type="radio"/> Beige <input type="radio"/> Grey <input type="radio"/> Blue	
<b>BEAM</b>	
<b>BEAM TYPE - (two 100 x 100 mm capped beams to set in the wall (45 mm))</b> To be delivered: <input type="checkbox"/> Yes <input type="checkbox"/> No <input type="radio"/> White <input type="radio"/> Beige <input type="radio"/> Grey	<b>SUPPORT TYPE</b> To be delivered: <input type="checkbox"/> Yes <input type="checkbox"/> No
<b>DECKING</b>	
<input type="checkbox"/> Smooth teak decking 65 cm <input type="checkbox"/> Aluminium decking 65 cm: <input type="radio"/> White <input type="radio"/> Beige <input type="radio"/> Grey <b>Options for aluminium decking:</b> <input type="checkbox"/> Non-slip tape <input type="checkbox"/> Cleaner	
<b>SECURIWALL</b>	
<input type="checkbox"/> Yes: <input type="radio"/> White <input type="radio"/> Beige <input type="radio"/> Grey <input type="checkbox"/> No	
<b>WINTER SHIFT / PROTECTIVE COVERING</b>	
<b>Ivernea:</b> <input type="checkbox"/> Yes (please complete the corresponding order form) <input type="checkbox"/> No <b>Ivernea Plus:</b> <input type="checkbox"/> Yes (please complete the corresponding order form) <input type="checkbox"/> No	

Remember to complete the order form on the next page.

ORDER FORM

# ROLLENERGY EVOLUTION AUTOMATIC COVER FOR AZTECK POOL KITS (2/2)

Customer N°:	Customer reference:	Order form date:	Company:
--------------	---------------------	------------------	----------

**POOL SHAPE AND DIMENSIONS (in m)**

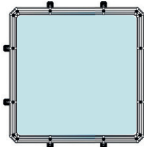
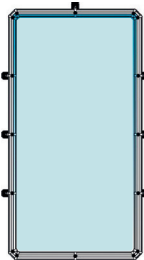
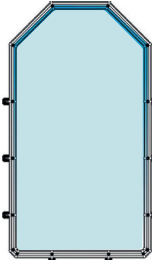
<input type="checkbox"/> <b>Square</b>  <input type="checkbox"/> 3.00 x 3.00 <input type="checkbox"/> 3.50 x 3.50 <input type="checkbox"/> 4.05 x 4.05	<input type="checkbox"/> <b>Rectangular</b>  <input type="checkbox"/> 2.50 x 5.10 <input type="checkbox"/> 3.50 x 8.30 <input type="checkbox"/> 3.00 x 3.50 <input type="checkbox"/> 4.05 x 5.60 <input type="checkbox"/> 3.50 x 5.10 <input type="checkbox"/> 4.05 x 7.30 <input type="checkbox"/> 3.50 x 6.70 <input type="checkbox"/> 4.05 x 8.90	<input type="checkbox"/> <b>Mixed</b>  Fill in the dimensions below.
---	--	---

**TAKING POOL MEASUREMENTS**

A 1 = .....	cm	B 1 = .....	cm
A 2 = .....	cm	B 2 = .....	cm
A 3 = .....	cm	B 3 = .....	cm
A 4 = .....	cm	B 4 = .....	cm
A 5 = .....	cm	B 5 = .....	cm
A 6 = .....	cm	B 6 = .....	cm
A 7 = .....	cm	B 7 = .....	cm
A 8 = .....	cm	B 8 = .....	cm
A 9 = .....	cm	B 9 = .....	cm
A 10 = .....	cm	B 10 = .....	cm
A 11 = .....	cm	B 11 = .....	cm
A 12 = .....	cm	B 12 = .....	cm
2 - 5 = .....	cm	5 - 8 = .....	cm
8 - 11 = .....	cm	C - 1 = .....	cm
C - 12 = .....	cm		

**INTERIOR POOL DIMENSIONS TO BE TAKEN AT THE WATER LINE AFTER COATING HAS BEEN MADE - MIXED-SHAPE AZTECK POOL KIT**

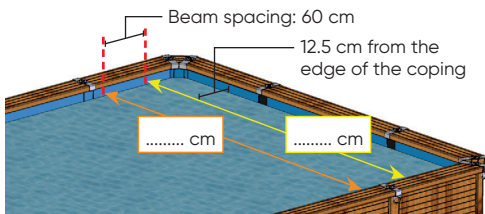
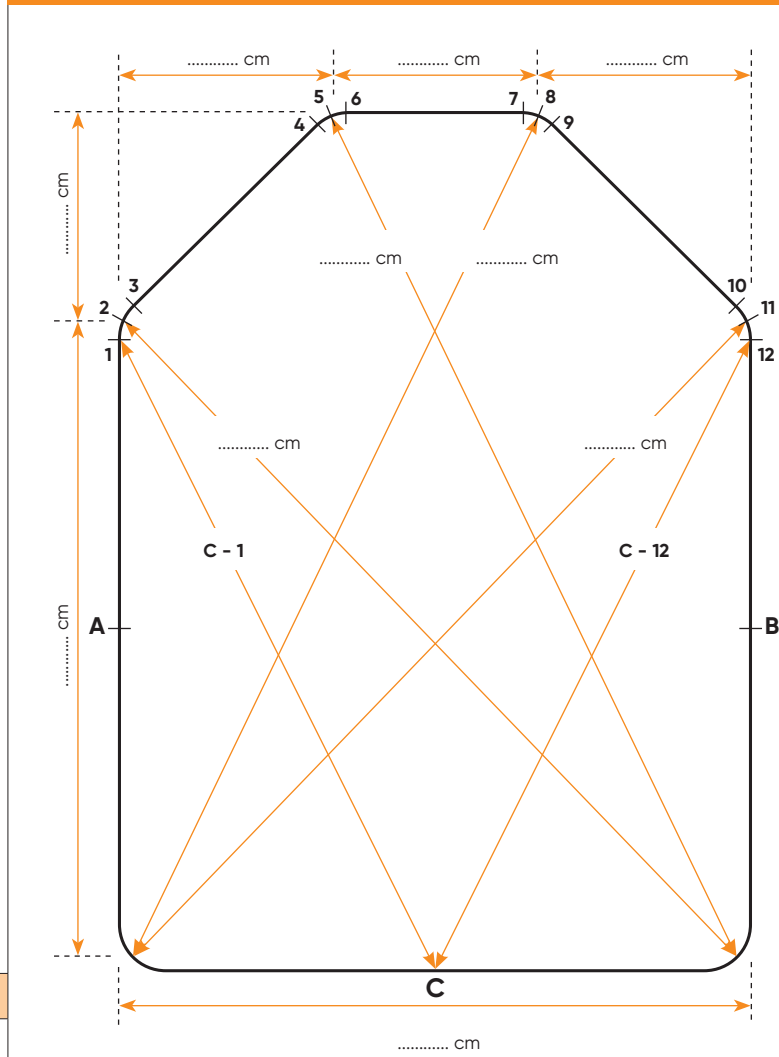

**ADDITIONAL INDICATIONS IF REQUIRED**

**TUBE / REEL SYSTEM SIDE**

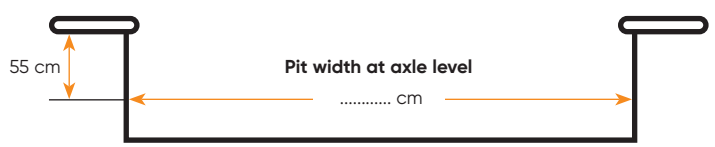



## ORDER FORM

## EQUINOX COVER FOR AZTECK POOL KITS

Customer N°:	Customer reference:	Order form date:
--------------	---------------------	------------------

<b>Company contact details:</b> Surname: ..... Postcode: ..... City: ..... Country: ..... Phone: ..... E-mail: .....	<b>Delivery address:</b> Name: ..... Address: ..... Postcode: ..... City: ..... Country: ..... Phone (person to contact): ..... Access: <input type="checkbox"/> Semi-trailer <input type="checkbox"/> Carrier Other: ..... Fill in the truck access checking guide on p. 43.
---	--

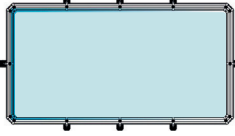
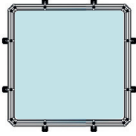
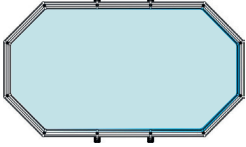
					
<b>ROLLER</b>					
Telescopic shaft					
<b>COLOURS</b>					
Bright grey (beige underside)					
<b>AZTECK POOL KIT MODEL</b>					
Shape	Dimensions (in m)	Equinox cover reference	Shape	Dimensions (in m)	Equinox cover reference
	<input type="checkbox"/> Ø 4.40	P-SSEA54444.C3		<input type="checkbox"/> 2.50 x 5.10	P-SSEA42551.C3
	<input type="checkbox"/> Ø 5.40	P-SSEA55454.C3		<input type="checkbox"/> 3.00 x 3.50	P-SSEA43035.C3
	<input type="checkbox"/> 3.00 x 3.00	P-SSEA13130.C3		<input type="checkbox"/> 3.50 x 5.10	P-SSEA43551.C3
	<input type="checkbox"/> 3.50 x 3.50	P-SSEA13535.C3		<input type="checkbox"/> 3.50 x 6.70	P-SSEA43567.C3
	<input type="checkbox"/> 4.05 x 4.05	P-SSEA14140.C3		<input type="checkbox"/> 3.50 x 8.30	P-SSEA43583.C3
	<input type="checkbox"/> 4.00 x 5.60	P-SSEA34056.C3		<input type="checkbox"/> 4.05 x 5.60	P-SSEA44156.C3
	<input type="checkbox"/> 4.00 x 7.30	P-SSEA34073.C3		<input type="checkbox"/> 4.05 x 7.30	P-SSEA44173.C3
	<input type="checkbox"/> 4.00 x 8.90	P-SSEA34089.C3		<input type="checkbox"/> 4.05 x 8.90	P-SSEA44189.C3
<b>ROLLING SYSTEM</b>					
<input type="checkbox"/> Crank - ref. P-ECCS01100 <input type="checkbox"/> Wheel - ref. P-ECCS01200					

# ORDER FORM TRUCK ACCESS CHECKING GUIDE

Company name:	Customer reference:
---------------	---------------------

## **i** INFO

To allow us to deliver to you with maximum efficiency, please fill in this questionnaire carefully. We decline all liability in the event of the required delivery location being inaccessible due to the indications you have provided. Any new deliveries will be invoiced to you. Thank you for your understanding.



### ORDERED EQUIPMENT

Pool kit

### ROAD SIGNAGE LEADING TO THE REQUESTED DELIVERY POINT

 Have you already seen this type of road sign on the road that leads to the requested delivery point?









**3.5 T**

Yes If so, please indicate which ones: .....

No



### ACCESS TO THE REQUESTED DELIVERY POINT: TYPES OF VEHICLE LIKELY TO HAVE ACCESS

Below are different vehicle types. Indicate which types are likely to be able to pass in front of the requested delivery location.

			
Tractor + trailer (38 tonnes): <input type="checkbox"/> Yes <input type="checkbox"/> No	Semi-trailer (38 tonnes): <input type="checkbox"/> Yes <input type="checkbox"/> No	Small carrier (19 tonnes): <input type="checkbox"/> Yes <input type="checkbox"/> No	Small truck (6 tonnes): <input type="checkbox"/> Yes <input type="checkbox"/> No
			
Garbage trucks: <input type="checkbox"/> Yes <input type="checkbox"/> No	Concrete mixer trucks: <input type="checkbox"/> Yes <input type="checkbox"/> No	Fuel delivery trucks: <input type="checkbox"/> Yes <input type="checkbox"/> No	Small van: <input type="checkbox"/> Yes <input type="checkbox"/> No

### TRUCK CLEARANCES: DETAILS

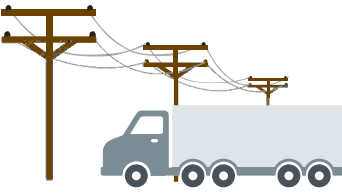
Be careful of the truck clearance: Is the delivery address subject to one of the below situations?

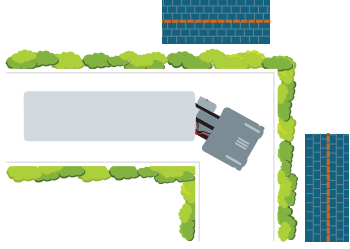
		
Electric cables: <input type="checkbox"/> Yes <input type="checkbox"/> No	Low branches: <input type="checkbox"/> Yes <input type="checkbox"/> No	Corners of roads: <input type="checkbox"/> Yes <input type="checkbox"/> No

### OTHER INDICATIONS, PLEASE DESCRIBE